

# Mini Controller *AIRTRONIC*\*







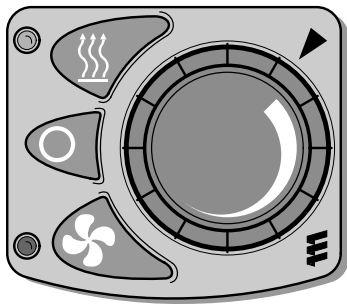

Operating Instructions / Mounting Instructions

Eberspächer®

GB



-  Temperature preselection control knob
  - Left-hand end stop approx. 8 °C – small amount of heat
  - Right hand end stop approx. 34 °C – large amount of heat
-  Heater
-  Red LED – Operation check for heater
-  Switch off (not in combination with mini clock)
-  Ventilator
-  Blue LED – operation check for ventilator

J. Eberspächer  
GmbH & Co.  
Eberspächerstr. 24  
D-73730 Esslingen

Telefon (zentral)  
(0711) 939-00  
Telefax  
(0711) 939-0500



[www.eberspaecher.com](http://www.eberspaecher.com)

Order No. 22 1000 32 07 00



The mini controller enables you to set the heater installed in the vehicle to the temperature you require. You can either use the mini controller alone or in combination with the mini-clock.

## Stand-alone mini-controller

### Start heater – heating mode:

Use the  button to start the heater in heating mode (continuous operation). You can adjust the required temperature with the control knob . If the heater is in heating mode, the red LED lights up as a check.

### Start heater – ventilation mode:

Use the  button to start the heater in ventilation mode (continuous operation). The control knob  has no function in ventilation mode. If the heater is in ventilation mode, the blue LED lights up as a check.

### Switch off heater:

Use the  button to switch off the heater. Heater or ventilation mode is terminated and the corresponding LED goes out. Heating mode is terminated with after run.

## Mini controller combined with the mini-clock

If the mini-controller is installed in a vehicle together with the mini-clock, the mini-clock takes over the switch on / off function. In addition, it is now possible to program preset times. Information about programming is given in the enclosed operating and installation instructions for the mini-clock.

### Note:

The  button has no function when the controller is used in combination with the mini-clock. You can only switch the heater on / off using the mini-clock.

### a) Heater is switched off (mini-clock inactive)

If the heater is switched off, it is possible to pre-select the heater or ventilation modes using the mini-controller. The heater itself can only be switched on via the mini-clock.

### Set preselected heater mode at the mini-controller:

Use the  button to select heater mode – the preselection is saved. You can adjust the set temperature required using the temperature-preset controller. The red LED lights up for approx. 3 secs as confirmation. However the heater is not started.

### Set preselected ventilation mode at the mini-controller:

Use the  button to select ventilation mode – the preselection is saved. The temperature-preset controller has no function in ventilation mode. The blue LED lights up for approx. 3 secs as confirmation. However the heater is not started.

### b) Heater is switched on (mini-clock active)

The ON / OFF button is used to switch on the saved mode (heater / ventilation – preselected by the mini-controller). If the heater is in Heater mode, the red LED lights up, in ventilation mode the blue LED lights up as a check.

### Change between heating and ventilation modes using the mini-controller:

Use the  button to change to heater mode. The set temperature required can be adjusted using the temperature preset controller. If the heater is in heater mode the red LED lights up as a check. The preset operating mode is updated.

Use the  button to change to ventilation mode.

The temperature-preset controller has no function in ventilation mode. If the heater is in ventilation mode, the blue LED lights up as a check. The preselected operating mode is updated. Heater mode is terminated with after run.

### Change the required set temperature using the mini-controller:

The required temperature can be adjusted at any time during heating mode using the temperature-preset controller.

### Emergency operation – error when presetting the operating mode:

The preset operating mode was not able to be saved. The red LED flashes for approx. 10 secs. The mini-controller then switches to emergency operation (Preset heater mode). The heater remains switched off. Emergency operation can be reversed by carrying out the preselection process again or using a voltage reset (pull out the fuse).

If the heater is switched on by the mini-clock in emergency mode, the red LED lights up and flashes. The heater is in heater mode with preset set value.

It is not possible to change the operating mode in emergency mode. The heater can only be switched off via the mini-clock.

## Installation and connection of the mini-controller

Stick the drilling template to the required place of installation.

Drill Ø 2.5 and 7.5 mm holes.

Remove the control knob from the mini-controller.

Fit the mini-controller with the elastic base.

Screw in fixing screw up to the end stop.

Put the control knob on the mini-controller – the arresting device in the control knob must be inserted in the keyway in the mini-controller.

Connect the mini-controller in accordance with the circuit diagram.

### Note:

The drilling template (removable and self-adhesive) is attached to the front.

Do not press the control field during installation.

### Installation drawing

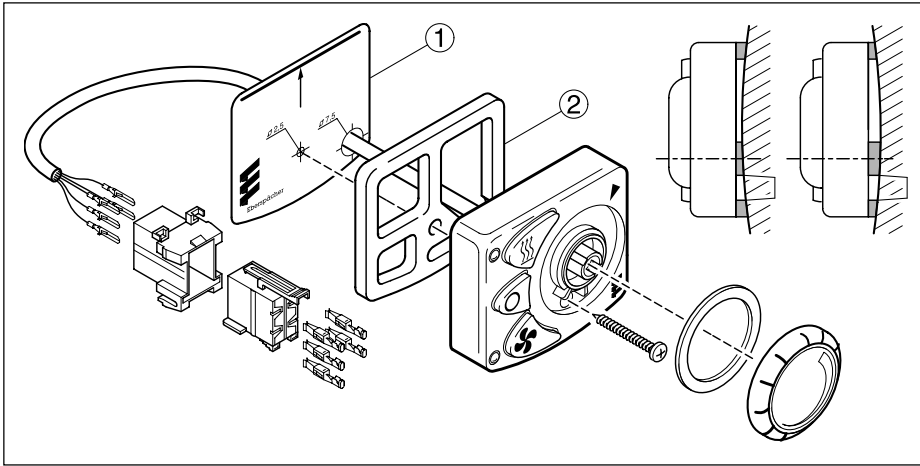

- ① Drilling template
- ② Elastic base for uneven installation area

### Circuit diagram

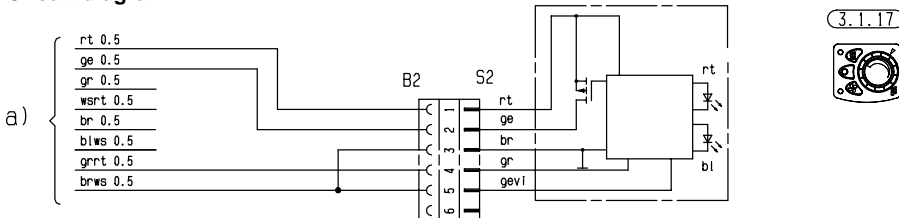

### Note:

If the mini controller is used in combination with the *CALLTRONIC* or TP5, the mini controller must be connected in accordance with the circuit diagrams in the respective technical instructions.

### Parts list

- 3.1.17 AIRTRONIC mini controller
- 3.2.12 Time switch mini (12 / 24 Volt)
- 3.3.6 Radio receiver TP41i

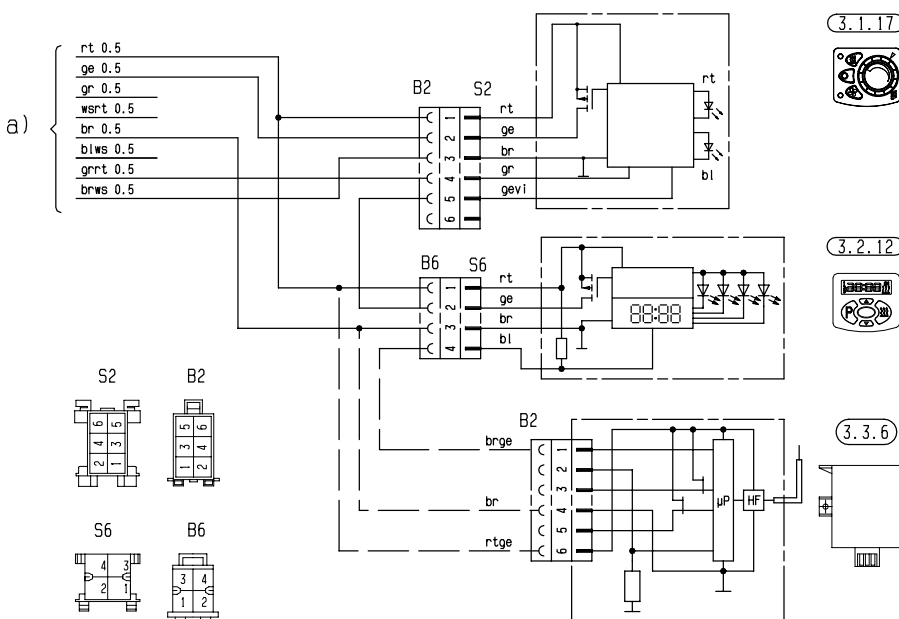

a) Connection of control elements on the heater

- rt Supply Plus, Terminal 30
- ge Switch on signal S+
- gr Actual temperature value
- ws rt Switch of anti-theft device
- br Supply Minus, Terminal 31
- bl ws Diagnosis
- gr rt Set temperature value
- br ws Sensor reference signal

Insulate any cable ends not used.

The connectors and socket housing are shown from the cable entry side.

### Cable colours

- sw = black
- ws = white
- rt = red
- ge = yellow
- gn = green
- vi = violet
- br = brown
- gr = grey
- bl = blue
- li = lilac